



Installation & Owner's Manual

MODEL

TST-MLD-I-WP24

Compatible with:

- RB, CB, UB, FB Fan Coil Units
 - RYB, UYB, CYB, FYB Split Systems
-

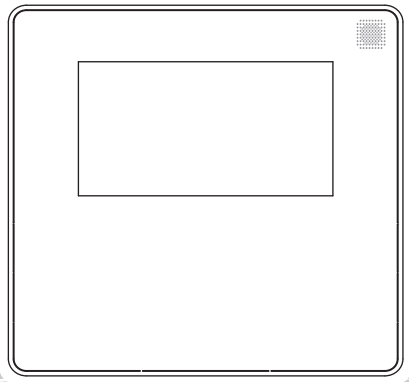

IMPORTANT NOTICE: Please read this manual carefully before installing or operating your wired remote controller. Make sure to save this manual for future reference.

This manual gives detailed description of the precautions that should be brought to your attention during operation.

In order to ensure correct service of the wired controller please read this manual carefully before using the unit.

For convenience of future reference, keep this manual after reading it.

All the pictures in this manual are for explanation purpose only. There may be slightly different from the wired remote controller you purchased (depend on model). The actual shape shall prevail.

Table of Contents

1. Safety precaution	1
2. Installation accessory	2
3. Installation method	4
4. Specification	9
5. Feature and function of the wired controller	10
6. Name on the LCD of the wired controller	11
7. Name of button on the wired controller	12
8. Preparatory operation	13
9. Operation	14
10. Timer functions	20
11. Weekly Timer 1	23
12. Weekly Timer 2	29
13. Fault alarm handing	36
14. Technical indication and requirement	36
15. Queries and settings	37

1. Safety precaution



WARNING

- Please entrust the distributor or professionals to install the unit.
- Installation by other persons may lead to imperfect installation, electric shock or fire.
- Adhere to this installation manual.
- Improper installation may lead to electric shock or fire.
- Reinstallation must be performed by professionals.

Do not uninstall the unit randomly.

Random uninstalling may lead to abnormal operation, heating or fire of the air condition.

NOTE

- Do not install the unit in a place vulnerable to leakage of flammable gases. Once flammable gases are leaked and left around the wire controller, fire may occur.
- Do not operate with wet hands or let water enter the wire controller. Otherwise, electric shock may occur.
- The wiring should adapt to the wire controller current. Otherwise, electric leakage or heating may occur and result in fire.

1. Safety precaution

NOTE

- The specified cables shall be applied in the wiring. No external force may be applied to the terminal. Otherwise, wire cut and heating may occur and result in fire.

2. Installation accessory

Select the installation location

Don't install at the place where cover with heavy oil, vapor or sulfureted gas, otherwise, this product would be deformed that would lead to system malfunction.

Preparation before installation

1. Please confirm that all the following parts you have been supply.

No.	Name	Qty.	Remarks
1	Wire controller	1	_____
2	Installation and owner's manual	1	_____
3	Screws	3	M3.9X25 (For Mounting on the Wall)
4	Wall plugs	3	For Mounting on the Wall
5	Screws	2	M4X25 (For Mounting on switch box)
6	Plastic screw bars	2	For fixing on switch box
7	Battery	1	_____
8	The connective wires group	1	Optional
9	Screw(Only available for the shielded wire with connection plug)	1	M4X8(For Mounting the connective wire group)
10	Magnetic ring	1	Use the magnetic ring to hitch the connective cable of the wire controller.

2. Installation accessory

2. Prepare the following assemblies on the site.

No.	Name	Qty.(embedded into wall)	Specification (only for reference)	Remarks
1	Switch box	1	_____	_____
2	Wiring Tube(Insulating Sleeve and Tightening Screw)	1	_____	_____

Precaution of installing the wire controller

1. This manual provides the installation method of wired controller. Please refer to the wiring diagram of this installation manual to connect the wire controller with indoor unit.
2. The wired controller works in low voltage loop circuit. Forbid to directly contact the cable of high voltage above, like 115V, 220V, 380V, and don't wire this kind of wire in the said loop; wiring clearance between configured tubes should be at the range of 300~500mm or above.
3. The Shielded wire of the wired controller must be grounded firmly.
4. Upon finish the wire controller connection, do not employed tramegger to detect the insulation.

3. Installation method

1. Wired remote controller structural dimensions

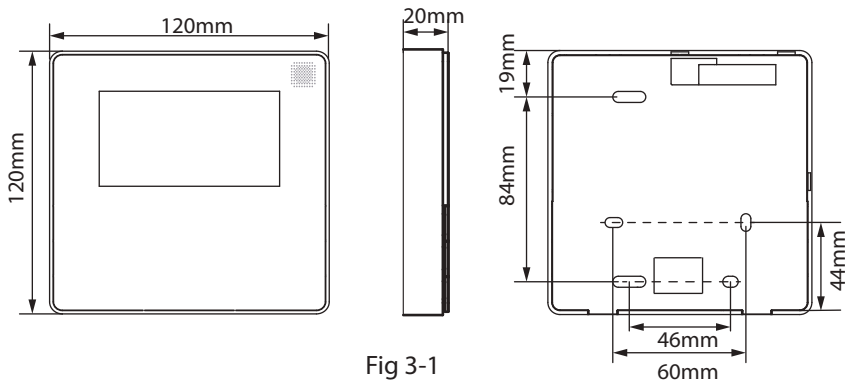

2. Remove the upper part of wired controller

- Insert a slot screwdriver into the slots in the lower part of the wired controller (2 places), and remove the upper part of the wire controller. (Fig.3-2)

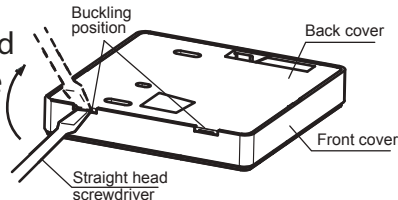

3. Installation method

NOTE: The PCB is mounted in the upper part of the wired controller. Be careful not to damage the board with the slot screwdriver.

3. Fasten the back plate of the wired controller

- For exposed mounting, fasten the back plate on the wall with the 3 screws (M4×20) and plugs. (Fig.3-3)

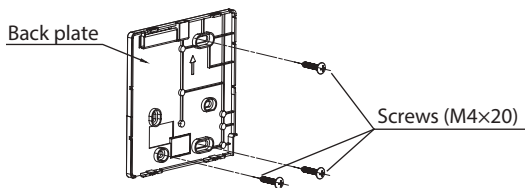

Fig 3-3

- Use two M4X25 screws to install the back cover on the 86 switch box, and use one M3.9X25 screw to fix to the wall.

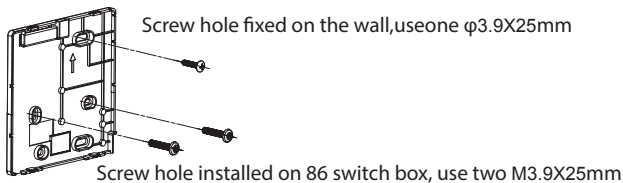

Fig 3-4

3. Installation method

NOTE: Put on a flat surface. Be careful not to distort the back plate of the wire controller by overtightening the mounting screws.

4. Battery installation

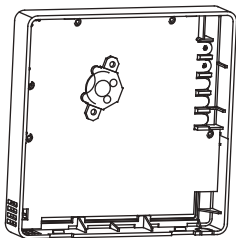

Fig 3-5

- Put the battery into the installationsite and make sure the positive side of the battery is in accordance with the positive side of installationsite.(See Fig.3-5)
- Please set the time corrected on the first time operation. Batteries in the wire controller can time under power failure which ensure the time keep right. When the power restores, if the time displayed is not correct, it means the battery is dead and replace the battery.

3. Installation method

5. Wire with the indoor unit

A

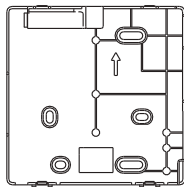
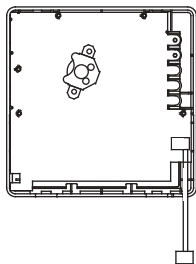

B

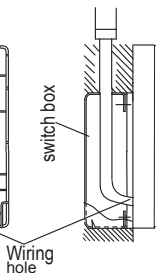
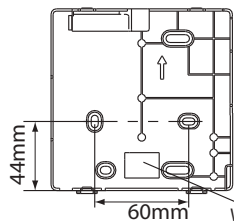

Fig 3-6

1 indoor unit

2 notch the part for the wiring to pass through with nippers, etc.

NOTE: DO NOT
allow water to enter
the remote control.
Use the trap and
putty to seal the
wires.

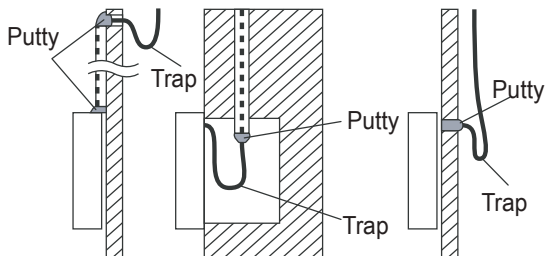
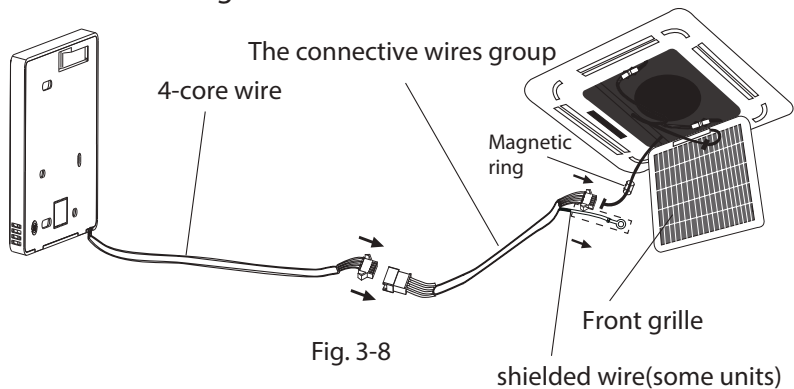

Fig 3-7

3. Installation method

6.Installation Diagram

Connect the wire from the master control board of the indoor unit to a connecting cable. Then connect the other side of the connecting cable to the remote control.



NOTE: Be sure to reserve a length of the connecting wire for periodic maintenance.
If there is a connection lug at the end of shielded wire, the connection lug should be properly grounded.

3. Installation method

7. Reattach the upper part of the wire controller

- After adjusting the upper case and then buckle the upper case; avoid clamping the wiring during installation. (Fig 3-9)

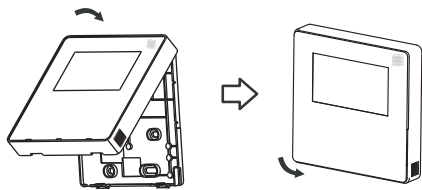

Fig 3-9

All the pictures in this manual are for explanation purpose only. Your wire controller may be slightly different. The actual shape shall prevail.

4. Specification

Input voltage	KJR-120X1/TFBG-E: DC 5V, KJR-120X2/TFBG-E: DC 12V
Ambient temperature	-5~43°C (23~110°F)
Ambient humidity	RH40%~RH90%

Wiring specifications

Wiring type	Size	Total length
shielded vinyl cord or cable	0.5-1.25mm ²	≤50m (164')

5. Feature and function of the wired controller

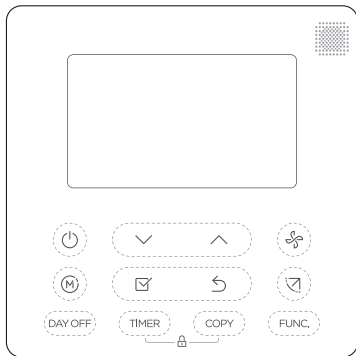

Feature:

- LCD display.
- Malfunction code display: it can display the error code, helpful for service.
- 4-way wire layout design, no raised part at backside, more convenient to place the wires and install the device.
- Room temperature display.
- Weekly Timer.

Function:

- Mode: choose Auto-Cool-Dry-Heat-Fan
- Fan speed: Auto/Low/Med/High speed
- Swing (on some models)
- Timer ON/OFF
- Temp setting
- Weekly timer
- Follow me
- Turbo
- 24-hour System
- 12-hour System
- Auto-restart
- Individual louver control (on some models)
- Automatic airflow test
- Child Lock
- LCD display
- Clock
- Panel function (on some models)

6. Name on the LCD of the wired controller

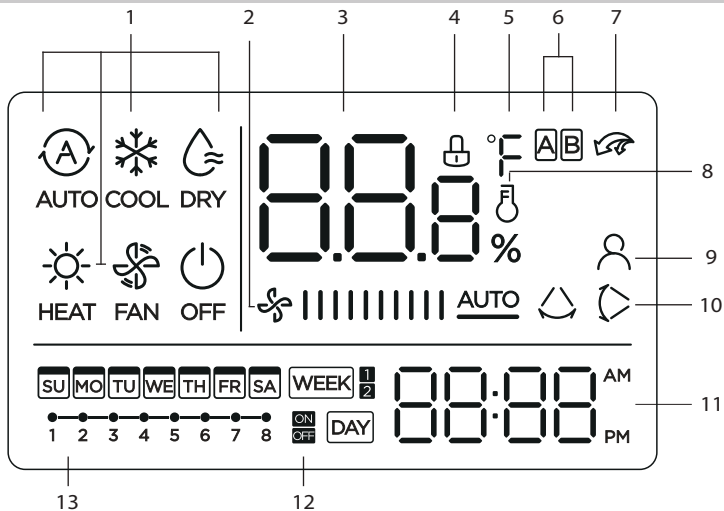

- 1 Operation mode indication
- 2 Fan speed indication
- 3 Temperature display
- 4 Lock indication
- 5 °C / °F indication
- 6 Main unit and secondary unit indication
- 7 Turbo function indication

- 8 Room temperature indication
- 9 Follow Me function indication
- 10 Left-right swing indication
(some models)
- 11 Clock display
- 12 On/Off timer
- 13 Timer display

7. Name of button on the wired controller

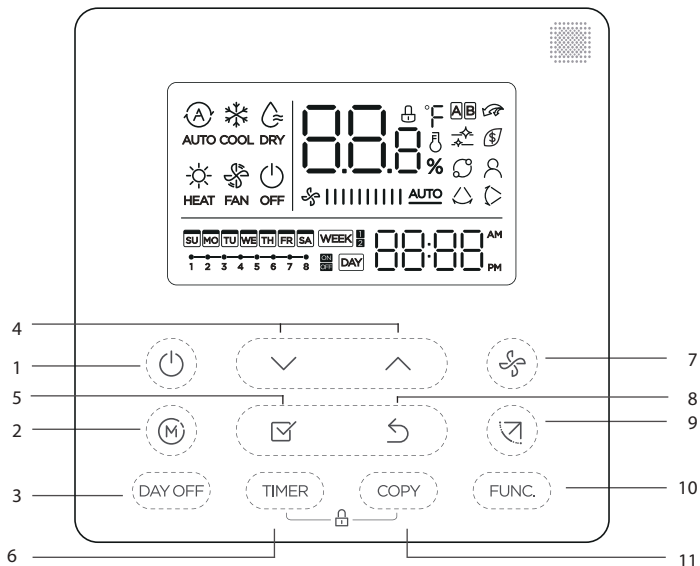

1 POWER button

2 MODE button

3 DAY OFF/DEL button

4 ADJUST button

5 CONFIRM button

6 TIMER button

7 FAN SPEED button

8 BACK button







9 SWING button

10 FUNC. button

11 COPY button

8. Preparatory operation

Set the current day and time

-  Press the Timer button for 2 seconds or more. The timer display will flash.
-  Press the button "∨" or "∧" to set the date. The selected date will flash.

-  The date setting is finished and the time setting is prepared after pressing Timer button or CONFIRM button or there is no pressing button in 10 seconds.
-  Press the button "∨" or "∧" to set the current time. Press repeatedly to adjust the current time in 1-minute increments. Press and hold to adjust the current time continuous.

ex. Monday 11:20
-  The setting is done after pressing CONFIRM button or there is no pressing button in 10 seconds.

9. Operation

6



Time scale selection
Press the buttons “TIMER” and “DAY OFF” for 2 seconds will alternatethe clock tieme display between the 12h&24h scale.

To start/stop operation



Press the Power button.

To set the operation mode

Operation mode setting



Press the Mode button to set the operation mode.(Heat function is invalid for cool only type unit)

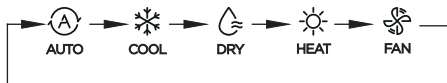

9. Operation

Room temperature setting

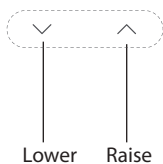

Press the button " ∨ " or " ^ " to set the room temperature.

Indoor Setting Temperature Range :
17~30°C(62~86°F).

°C & °F scale selection(on some models)

Press the buttons " ∨ " and " ^ " for 3 seconds will alternate the temperature display between the °C & °F scale.

Fan speed setting



Press the Fan speed button to set the fan speed.
(This button is unavailable when in the mode of Auto or Dry)

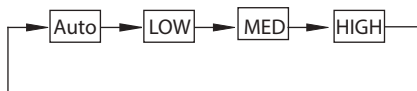

keypad tone setting





Press the buttons Swing and FUNC. for 3 seconds to close the keypad tone.
Press the buttons again for 3 seconds to open the keypad tone.

9. Operation

Child lock function



Press the buttons “  ” and “  ” for 3 seconds to activate the child lock function and lock all buttons on the wire controller.

Press the buttons again for 3 seconds to deactivate the child lock function.

When the child lock function is activated, the  mark appears.

Swing function(For the unit left & right auto swing models only)

1 Up-Down swing



Press the SWING button to start up-down swing function. Press it again to stop.

When the Up-Down swing function is activated, the  mark appears.

2 Left-Right swing

Press the Swing button long to start Left-Right swing function. Press it again to stop. When the Left-Right swing function is activated, the  mark appears.

9. Operation

Swing function(For the unit without left & right auto swing function models)

Up-Down airflow direction and swing



- Use Swing button to adjust the Up-down airflow direction.

- 1.Press the button every time, the louver swings 6 degrees.
- 2.Press and hold the button for 2 seconds,it turns into up-down swing mode,press ti again to stop. When the Up-Down swing function is activated,the  mark appears. (Not applicable to all the models)

- The operation can refer to the following instructions for the unit with four Up-Down louvers can be operated individually.



- 1.Press the Swing button to activate the Up-Down adjusting louver function.
The  mark will flash.(Not applicable to all the models)

9. Operation

2. Pressing the button “ \checkmark ” or “ \wedge ” can select the movement of four louvers. Each time you push the button, the wire controller select in a sequence that goes from: (the icon  means the four louvers move at the same time.)

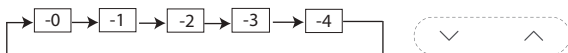

3. And then use Swing button to adjust the Up-Down airflow direction of the selected louver.



Press the FUNC. button to set the turbo or lfeel function.



The select function icon will flash then press the Confirm button to confirm the setting.



9. Operation

Turbo function (on some models)



Under COOL/HEAT mode, press the FUNC. button to activate the turbo function. Press the button again to deactivate the turbo function. When the turbo function is activated, the  mark appears.

Follow me function indication

Press the FUNC. button to select whether the room temperature is detected at the indoor unit or the wire controller.

When the follow me function indication appears, the room temperature is detected at the wire controller. 

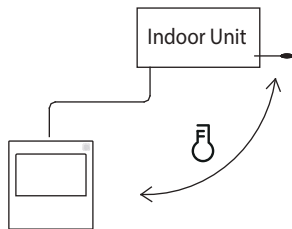

Press the button again to cancel the follow me function.

10. Timer functions

WEEK

WEEKLY timer

Use this timer function to set operating times for each day of the week.

ON

DAY

On timer

Use this timer function to start air conditioner operation. The timer operates and air conditioner operation starts after the time has passed.

OFF

DAY

Off timer

Use this timer function to stop air conditioner operation. The timer operates and air conditioner operation stops after the time has passed.

ON
OFF

DAY

On and Off timer

Use this timer function to start and stop air conditioner operation. The timer operates and air conditioner operation starts and stops after the time has passed.

10. Timer functions

To set the On or Off TIMER

- 1  Press the Timer button to select the **ON DAY** or **OFF DAY**.



- 2  Press the Confirm button and the Timer display is flashing.





ex. Off timer set at 18:00

Press the button “∨” or “∧” to set the time.
After the time is set, the timer will start or stop automatically.



- 4  Press the Confirm button again to finish the settings.



10. Timer functions

To set the On and Off TIMER

-  Press the Timer button to select the  .

-  Press the Confirm button and the Clock display is flashing.

-   Press the button “∨” or “∧” to set the time of On timer, and then press the Confirm button to confirm the setting.

-   Press the button “∨” or “∧” to set the time of Off timer.

-  Press the Confirm button to finish the settings.

11. Weekly Timer 1

1 Weekly timer setting



Press the Timer button to select the **WEEK** and then press the Confirm button to confirm.



2 Day of the week setting



Press the button “∨” or “∧” to select the day of the week and then press the Confirm button to confirm the setting.



3 ON timer setting of timer setting 1



Press the button “∨” or “∧” to set the time of On timer and then press the Confirm button to confirm the setting.



11. Weekly Timer 1

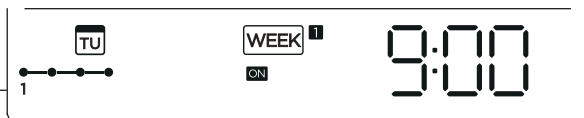

ex. Tuesday time scale 1

Up to 4 timer settings can be saved for each day of the week. It is convenient if the WEEKLY TIMER is set according to the user's life style.

4 Off timer setting of timer setting 1



Press the button "∨" or "∧" to set the time of Off timer and then press the Confirm button to confirm the setting.

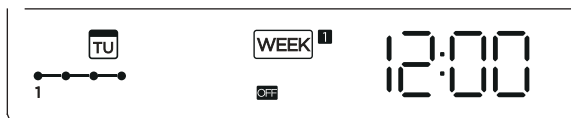

ex. Tuesday time scale 1

- 5 Different timer settings can be set by repeating step 3 to 4.
- 6 Other days in one week can be set by repeating step 2 to 5.

NOTE: The weekly timer setting can be returned to the previous step by pressing Back button. The time of timer setting can be delete by pressing Day off botton The current setting will be restored and withdrawn the weekly timer setting automatically when there is no operation for 30 seconds.

11. Weekly Timer 1

WEEKLY timer operation

To activate WEEKLY TIMER operation

Press the Timer button while **WEEK** is displayed on the LCD.

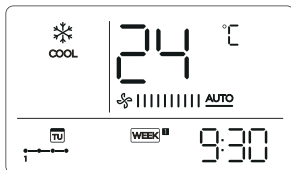

ex.

To deactivate WEEKLY TIMER operation



Press the Timer button while **WEEK** disappears from the LCD.

To turn off the air conditioner during the weekly timer



1. If press the Power button once and quickly, the air conditioner will turn off temporarily. And the air conditioner will turn on automatically until the time of On timer.

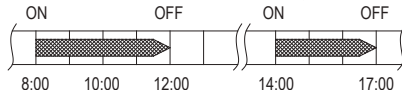





ex. If press the POWER button once and quickly at 10:00, The air conditioner will turn on at 14:00.

2. When press the Power button for 2 seconds, the air conditioner will turn off completely, at the same time cancel the timing function.

11. Weekly Timer 1

To set the DAY OFF (for a holiday)

-  During the weekly timer, press the Confirm button.
-  Press the button “∨” or “∧” to select the day in this week.
-  Press the Day off button to set the DAY OFF.

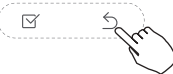
ex.The DAY OFF is set for Wednesday
- The DAY OFF can be set for other days by repeating the steps 2 and 3.
-  Press the Back button to back to the weekly timer.

To cancel: Follow the same procedures as those for setup.

Notes:

The DAY OFF setting is cancelled automatically after the set day has passed.

11. Weekly Timer 1

DELAY function



During the weekly timer, pressing the Del button once, display "0h". Press this button twice, display "1h" and wait 3 seconds to confirm. It means the unit will override 1 hours; Press this button three times, display "2h" and wait 3 seconds to confirm. It means the unit will override 2 hours;

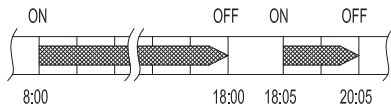
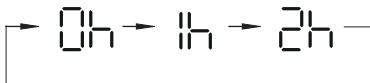

ex. If press the DEL button to select "2h" at 18:05 ,
The air conditioner will delay to turn off at 20:05.

Copy out the setting in one day into the other day.

A reservation made once can be copied to another day of the week. The whole reservation of the selected day of the week will be copied. The effective use of the copy mode ensures ease of making reservations.







During the weekly timer, press the Confirm button.

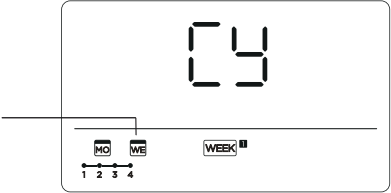

Press the button "∨" or "∧" to select the day to copy from.

11. Weekly Timer 1

- 3  Press the Copy button, the letter "CY" will be shown on the LCD.
-
- 4  Press the button "∨" or "∧" to select the day to copy to.
-
- 5  Press the Copy button to confirm .
- The **WE** mark flashes quickly
- 
- ex. Copy the setting of Monday to Wednesday
-
- 6 Other days can be copied by repeating step 4 and 5.
-
- 7  Press the Confirm button to confirm the settings.
-
- 8  Press the Back button to back to the weekly timer.

12. Weekly Timer 2

1 Weekly timer setting

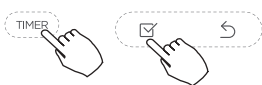

Press **TIMER** to select the **WEEK** and press **Confirm**.

2 Day of the week setting



Press "**∨**" or "**∧**" to select the day of the week and then press **CONFIRM**.

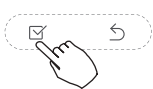

3 ON timer setting of timer setting 1



Press "**∨**" or "**∧**" to select the setting time. The setting time, mode, temperature and fan speed appear on the LCD. Press **CONFIRM** to enter the setting time process.



12. Weekly Timer 2

IMPORTANT: Up to 8 scheduled events can be set on one day. Various events can be scheduled in either **MODE**, **TEMPERATURE** and **FAN** speeds.

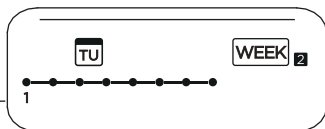

ex. Tuesday time scale 1

4 Time setting

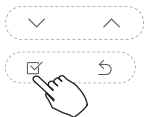

Press “ \vee ” or “ \wedge ” to set the time then press CONFIRM.

5 Operation mode setting

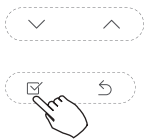

Press “ \vee ” or “ \wedge ” to set the operation mode then press CONFIRM.

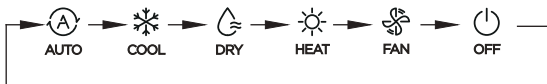

6 Room temperature setting

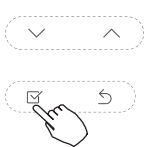

Press “ \vee ” or “ \wedge ” to set the room temperature then press CONFIRM.

NOTE: This setting is unavailable in the **FAN** or **OFF** modes.

12. Weekly Timer 2

7 Fan speed setting



Press “ \vee ” or “ \wedge ” to set the fan speed then press CONFIRM.



NOTE: This setting is unavailable in the AUTO, DRY or OFF modes.

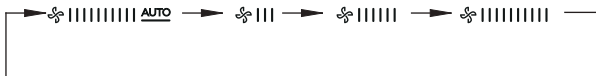

-
- 8 Different scheduled events can be set by repeating steps 3 through 7.**
- 9 Additional days, in a one week period, can be set by repeating steps 3 through 8.**

NOTE: The weekly timer setting can be returned to the previous step by pressing BACK. The current setting is restored. The controller will not save the weekly timer settings if there is no operation within 30 seconds.

12. Weekly Timer 2

WEEKLY timer operation

To start



Press Timer to select the **WEEK** , and then the timer starts automatically.

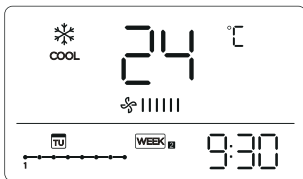

ex.

To cancel



Press the Power buttons for 2 seconds to cancel the timer mode.



The timer mode can also be canceled by changing the timer mode using Timer.

To set the DAY OFF (for a holiday)



1



After setting the weekly timer, press CONFIRM.

2



Press "  " or "  " to select the day of the week.

12. Weekly Timer 2

- 3 Press DAY OFF to create an off day.

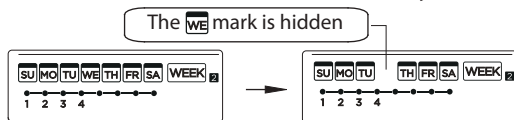

ex.The DAY OFF is set for Wednesday

- 4 Set the DAY OFF for other days by repeating the steps 2 and 3.

- 5  Press BACK to revert to the weekly timer.



To cancel, follow the same procedures used for setup.

NOTE: The DAY OFF setting is cancelled automatically after the set day has passed.

Copy out the setting in one day into the other day.

A scheduled event, made once, can be copied to another day of the week. The scheduled events of the selected day of the week will be copied. The effective use of the copy mode ensures the ease of reservation making.

- 1  In the weekly timer, press CONFIRM.



12. Weekly Timer 2

2  Press "∨" or "∧" to select the day to copy from.

3  Press COPY, the letters CY appear on the LCD.

4  Press "∨" or "∧" to select the day to copy to.

5 Press COPY to confirm.



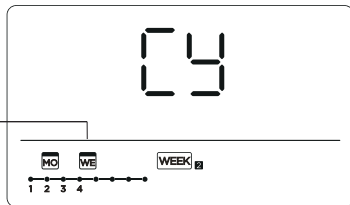

The  mark flashes quickly



ex. Copy the setting of Monday to Wednesday

6 Other days can be copied by repeating steps 4 and 5.



7  Press CONFIRM to confirm the settings.

8  Press BACK to revert to the weekly timer.

12. Weekly Timer 2

Delete the time scale in one day.

1  During the weekly timer setting, press CONFIRM.

2  Press "∨" or "∧" to select the day of the week and then press CONFIRM.

3  

Press "∨" or "∧" to select the setting time want to delete. The setting time, mode, temperature and fan speed appear on the LCD. The setting time, mode, temperature and fan speed can be deleted by pressing the DEL (day off).

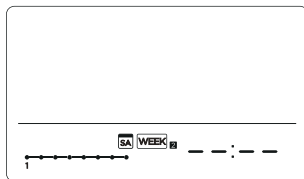
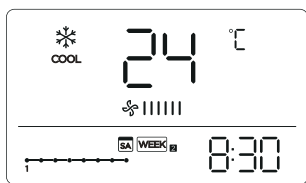

ex. Delet the time scale 1 in saturday

13. Fault alarm handing

If the system does not properly operate except the above mentioned cases or the above mentioned malfunctions is evident, investigate the system according to the following procedures.

NO.	MALFUNCTION & PROTECTION DEFINE	DISPLAY DIGITAL TUBE
1	Error of communication between wire controler and indoor unit	EH63

The error displayed on the wire controller are different from those on the unit. If error code appears, please check the <<Owner's And Installation Manual>>and<<SERVICE Manual>>.

14. Technical indication and requirement

EMC and EMI comply with the CE certification requirements.

15. Queries and settings



When the air conditioning unit is switch machine, Long press "COPY" for 3 seconds to enter a query indoor unit Tn(T1~T4) temperature and fan fault(CF), press "∨" or "∧" to select.



Not operating keys 15 seconds or press "Back" or press "ON/OFF" drop out of query temperature.



When the air conditioning unit is off, into the query function of temperature, press "∨" or "∧" to select SP, press "Confirm" to adjust the static pressure value.



When the air conditioning unit is off, into the query function of temperature, press "∨" or "∧" to select AF, press "Confirm" into test mode, press "Back" or press "ON/OFF" or press "Confirm" drop out of test mode.

In AF mode, 3~6 minutes test completion automatically exits, if the test process, press "Back" or press "ON/OFF" or press "Confirm", the test exits will be interrupted.

15.Queries and settings

Follow me function temperature compensation



LF

When the air conditioning unit is off, into the query function of temperature, press“∨”or“∧”to select tF. The compensation temperature Range : -5°C~5°C. Press “Confirm” into setting state, press“∨”or“∧”to select the temperature, then press “Confirm” to complete it.

LF : compensation temperature



TYPE

When the air conditioning unit is off, into the query function of temperature, press“∨”or“∧”to select tyPE. Press “Confirm” into setting state, press“∨”or“∧”to select the type, then press “Confirm” to complete it.

CH:     
AUTO COOL DRY HEAT FAN

CC:   
COOL DRY FAN

HH:  
HEAT FAN

NA:    
COOL DRY HEAT FAN

15. Queries and settings

Set the highest and lowest temperature values



When the air conditioning unit is off, into the query function of temperature, press "∨" or "∧" to select tHI or tLo. Press "Confirm" into setting state, press "∨" or "∧" to select the temperature, then press "Confirm" to complete it.

The highest setting temperature range : 25°C~30°C

The lowest setting temperature range: 17°C ~24°C.

tHI : Highest value setting function.

tLO : Minimum value setting function.

Remote control function selection of wire controller



When the air conditioning unit is off, into the query function of temperature, press "∨" or "∧" to select rEC. ON or OF will be displayed in the temperature area to indicate whether it is valid or invalid.

When the selection is invalid, the wire controller does not process any remote control signals.

Press "Confirm" into setting state, press "∨" or "∧" to select , then press "Confirm" to complete it.

15.Queries and settings

Restore factory Settings



When the air conditioning unit is off, into the query function of temperature, press "∨" or "∧" to select INIt, the temperature zone displayed --.



Press "Confirm" into setting state, press "∨" or "∧" to select to "ON", then press "Confirm" to complete it.



17.1°C : Restore factory Settings .

After the wire controller resumes the factory parameter setting, compensation of body temperature is uncompensated; COOL and HEAT/single COOL mode is restored to COOL and HEAT model; The temperature range was restored to 17 °C~30°C. Remote receiving function is restored to be effective.

The design and specifications are subject to change without prior notice for product improvement. Consult with the sales agency or manufacturer for details.